



Policy objective 5 – Europe closer to citizens

Tools for integrated territorial development

**EGTCUM meeting
18/06/2018**

**Regional
and urban
Policy**

Reinforce the integrated and place-based approach

- The EU must be able to **respond to the expectations of its citizens**, irrespective of where they live
- The number of **place-based sectorial initiatives**, notably targeting cities, is booming rapidly, but nor national, nor regional, nor local sectoral measures can alone deliver sufficient results.
- Need for economic, social, and environmental **sustainability and resilience in all places**
- Different territories and communities require differentiated and **tailor-made policy mixes**

Lessons learned

- **Need for simplification**
 - Lower implementation rate (34% project selection rate, end of 2017) irrespective to the applied territorial delivery mechanism (ITI, multi-thematic priority axis).
 - Novelty of integrated approaches and complexity of challenges can explain the delays sometimes, but complicated implementation systems can be streamlined.
- **More thematic flexibility**
 - Thematic focus were often limiting and set before the selection of local strategies without considering the actual development needs and potentials
- **Challenges in multi-level governance**
 - Delegation of project selection (IB) was too burdensome, while the actual role and responsibilities of cities and territories remained unclear.
- **Recognising the role of cities in regional development**
 - Increased focus on sustainable urban development (way more than 5%), but a rather fragmented urban dimension and initiatives
- **Functional area approach and urban-rural linkages**
 - were promoted successfully, but difficulties in identifying the exact territorial and thematic focus of integrated strategies.
- **Strengthening participation**
 - Partnership principle should be strengthened when preparing and implementing programmes and strategies. Use of CLLD remained limited in Cohesion Policy, and rarely used in urban development.

Integrated Territorial Development

Shared management

(Partnership + Multi-level governance)



COHESION POLICY

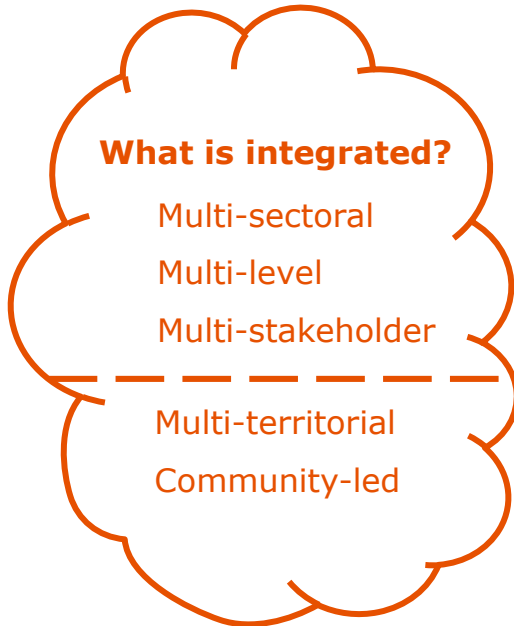

Integrated	Place-based
Macroregional strategies	Transnational/cross-border
Partnership Agreement	National
Programmes	Regional/national
Territorial strategies (Art. 23)	Functional (<i>Functional urban area</i>)
Local strategies (Art. 26)	Subregional (<i>metropolitan region</i>)
	Local admin (<i>City/town/suburb</i>)
	Community (<i>urb. neighbourhood</i>)

What is Integrated territorial development? (Art. 22)

Policy objective 5 + territorial instruments

- ITI (PO1-5)
- CLLD (PO1-5)
- Other (PO5)

SUD 6%

What is Integrated Territorial Development?

(new CPR Art. 23)

Minimum requirement 1: Investments based on integrated territorial or local development strategies (*multi-sectoral, multi-stakeholder, optionally multi-territorial*)

Minimum requirement 2: relevant local or territorial body shall select or shall be involved in the selection of operations (*multi-level, optionally community-led*)

- All investments under Policy objective 5 (ITI, CLLD, other)
- All investments under other POs using territorial instruments (ITI, CLLD)

What is Integrated?

A **strategic approach**, which combines

- **Multi-sectoral approach**
- **Multi-level governance approach**
- **Multi-stakeholder approach**

+ *Functional area approach*

+ *Community-led approach*

What is Territorial?

Going beyond national and regional level

- **Functional territories (crossing administrative boundaries)**
- **Sub regional administrative entities (NUTS 3 and below)**
- **Local communities**

Territories must be underpinned by common challenges, development needs and growth potentials.

What is Sustainable Urban Development? (new ERDF/CF Art. 9)

Integrated territorial development targeting urban areas.

- All investments under PO5 specific objective 1 (per definition for urban areas)
- All investments under PO1-4 territorial instruments (ITI, CLLD) targeting urban areas

Minimum 6% ERDF



Minimum requirements for integrated territorial development must apply!

What is an Urban focus? *(new CPR Annex 1)*

Interventions targeting:

- **Urban neighbourhood**
- **Administrative unit of a City, Town or Suburb**
- **Functional urban area** (It can also cover all actions to promote **urban-rural linkages**)

Territorial focus will be monitored together with the delivery mechanisms

What about other territories? *(new CPR Annex 1)*

Interventions targeting:

- **Mountains**
- **Islands**
- **Sparsely populated**
- **Any other territorial focus**



Also a mainstream investment can have a territorial focus, e.g. a specific call for islands! Territorial focus is not about location!

Territorial focus will be monitored together with the delivery mechanisms

What are the delivery mechanisms? (new CPR Art. 22)

Three forms for **integrated territorial development**:

- **CLLD**: if implemented using a specific bottom-up method
- **ITI**: if programmed `horizontally` through multiple priorities, or even programmes, funds or POs
- **Other**: if programmed through an integrated PO5 priority



ITI and Other are about how to programme for integrated territorial development, CLLD is about how to implement!

Scenario 1

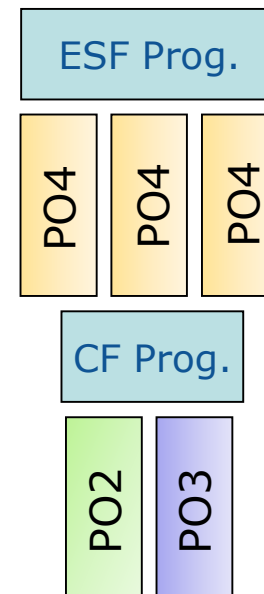
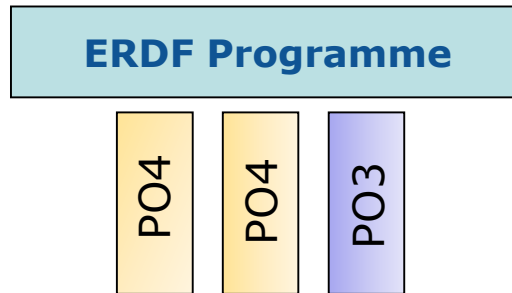
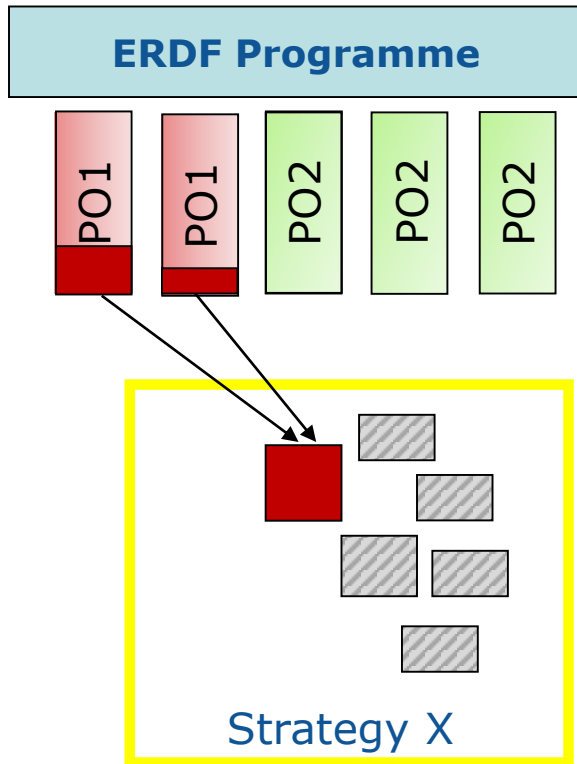

Delivery mechanism: **ITI, CLLD**

+ additional resources from **ESF and CF through mainstream calls**, where appropriate

Scenario 2

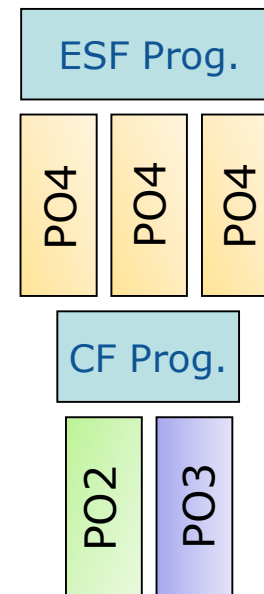
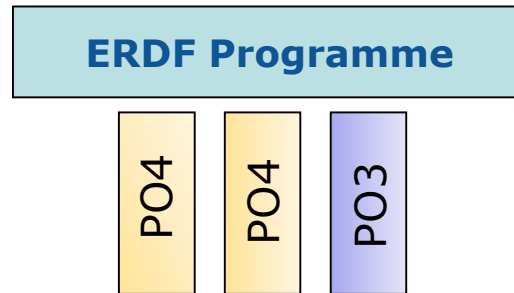
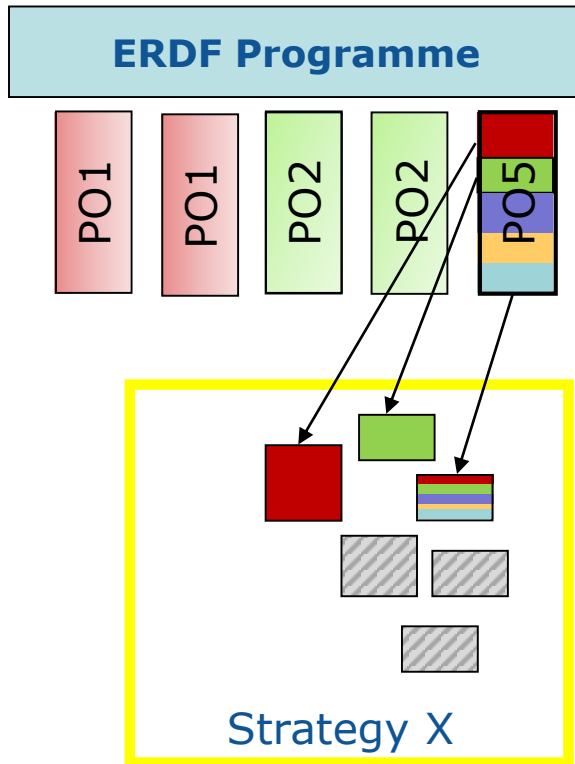

Delivery
mechanism:
OTHER, CLLD

+ additional
resources from
**ESF and CF
through
mainstream
calls**, where
appropriate

Scenario 3

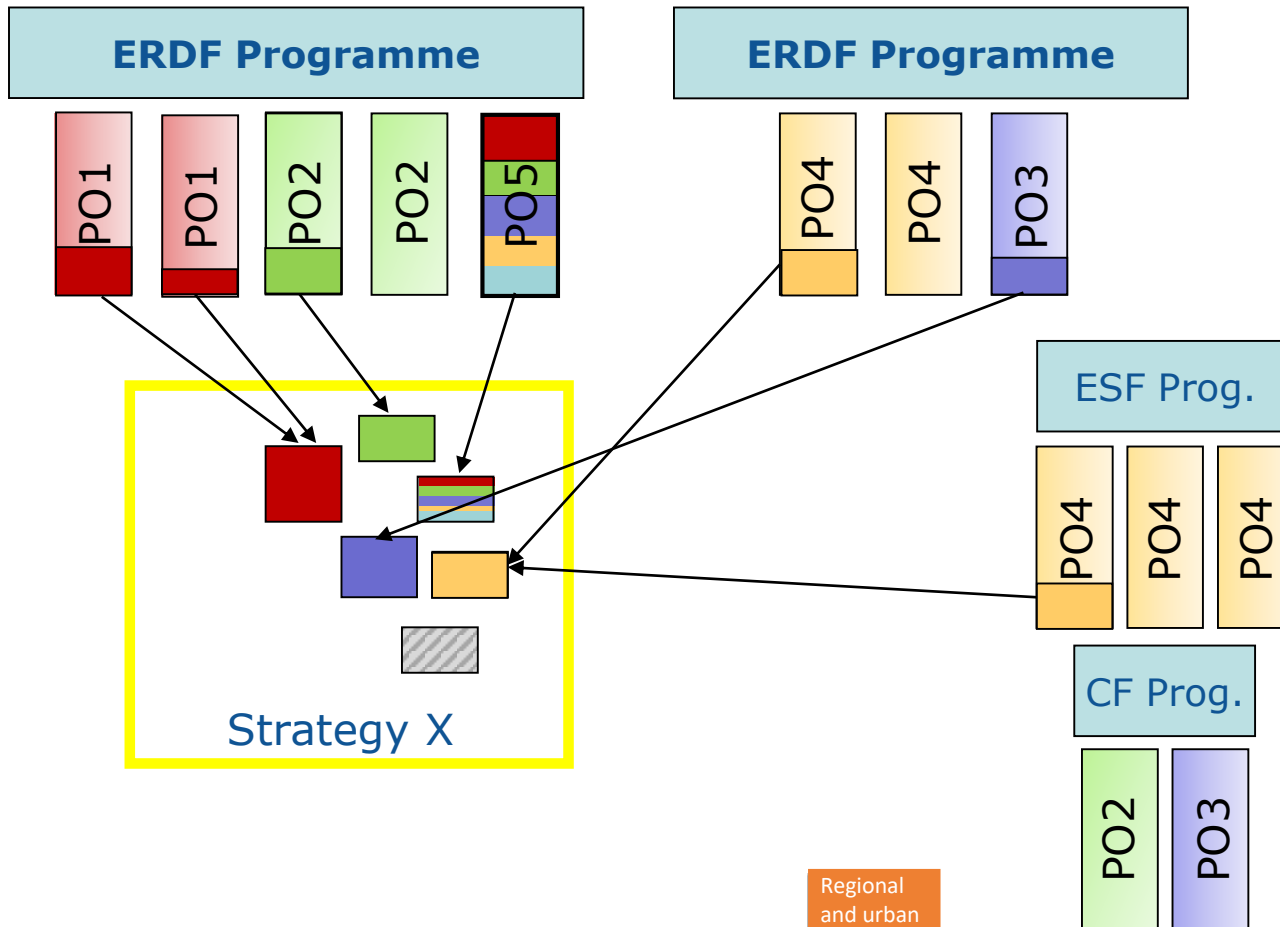

Delivery
mechanism: **ITI,**
CLLD

+ additional
resources from
ESF and CF
through
ITI/CLLD and
mainstream calls,
where appropriate

Thank you for your attention!



www.ec.europa.eu/info/region



www.twitter.com/@EU_Regional



DG REGIO collaborative platform
www.yammer.com/regionetwork



www.flickr.com/euregional



www.facebook.com/EuropeanCommission



www.linkedin.com/company/1809



plus.google.com/+EuropeanCommission



Sign up for our 'REGIOFLASH'
www.info/regionodoc